

FL1515L

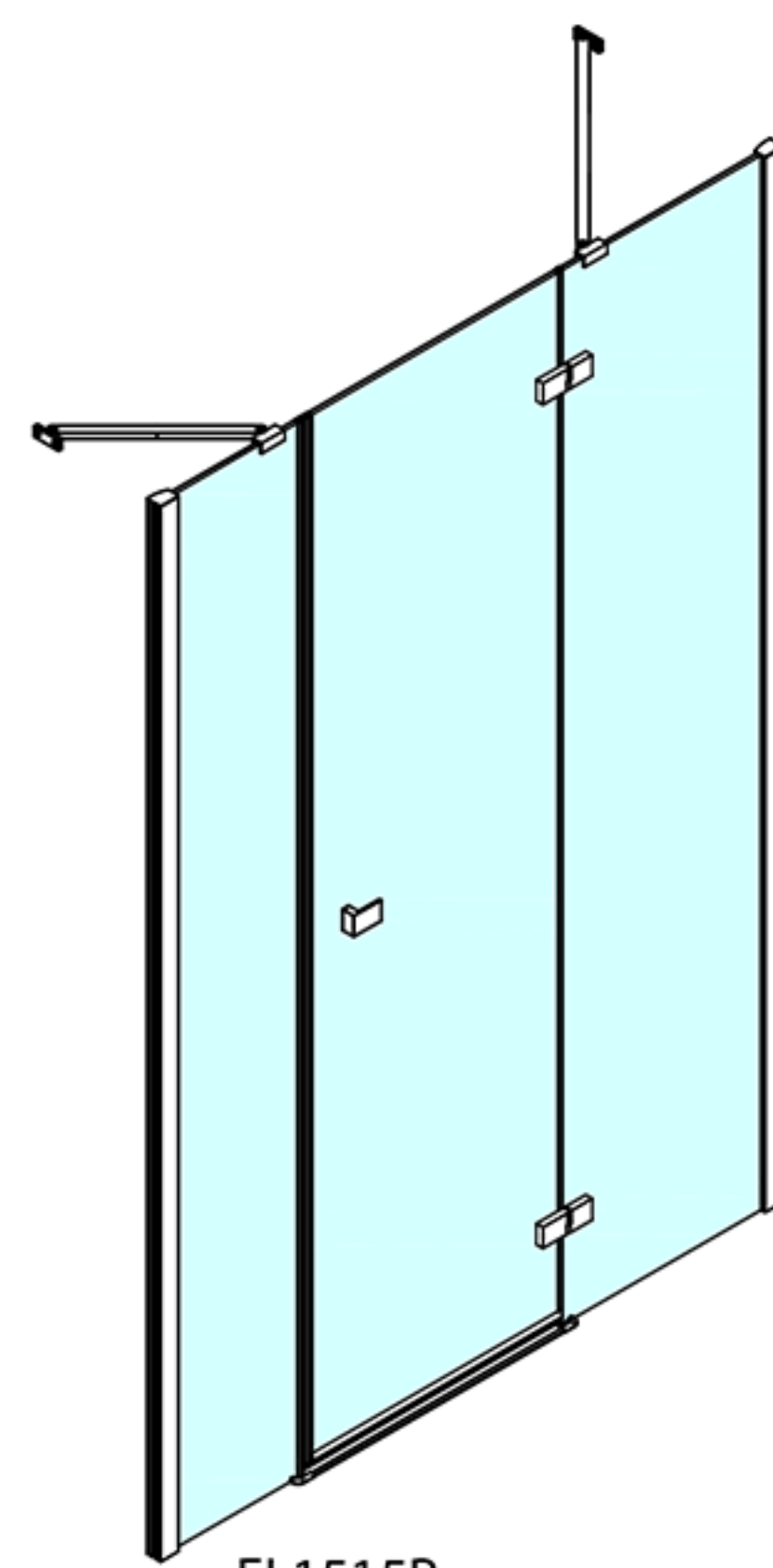

FL1515R

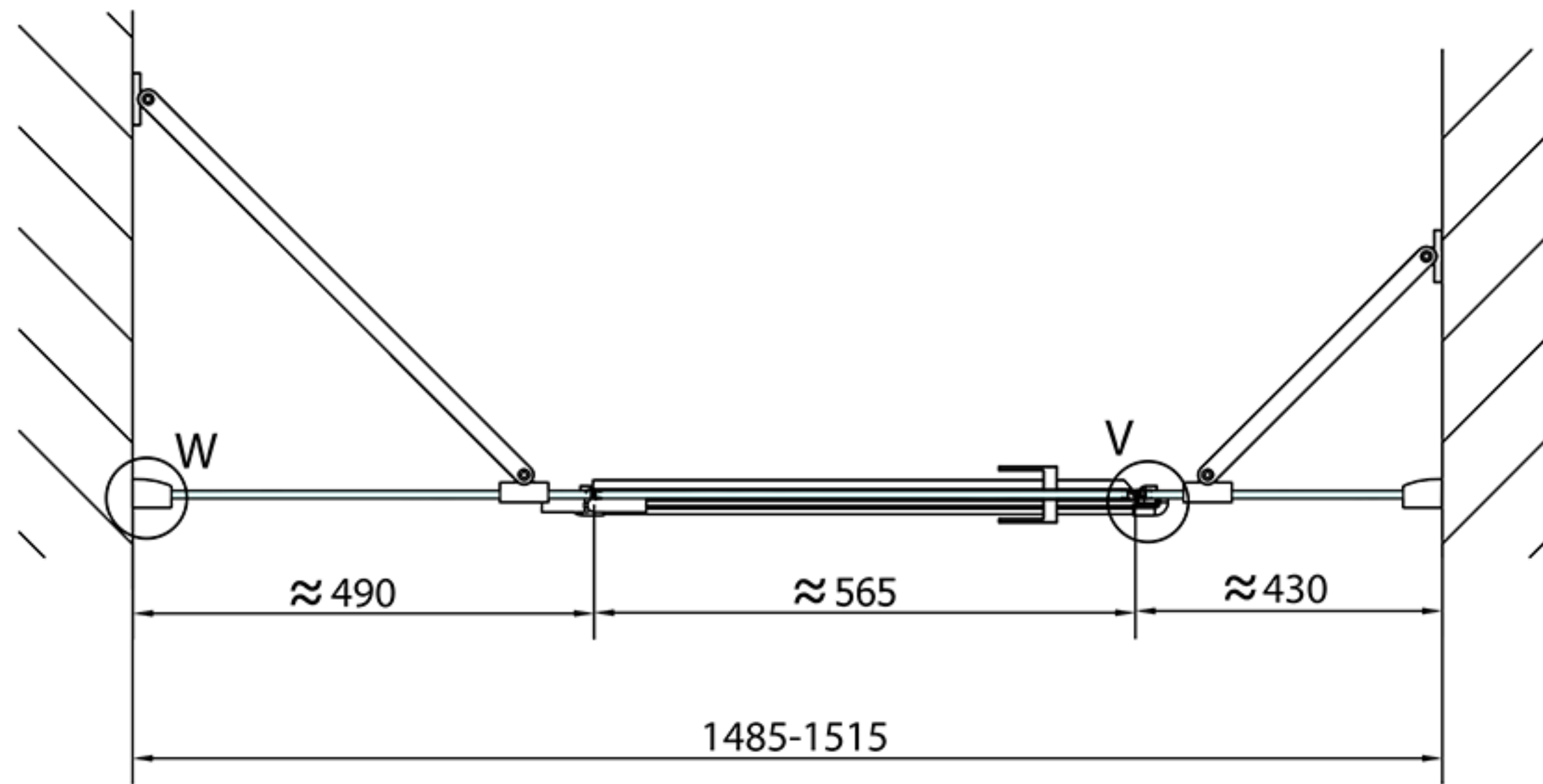

W

V

