

kielle

40118004

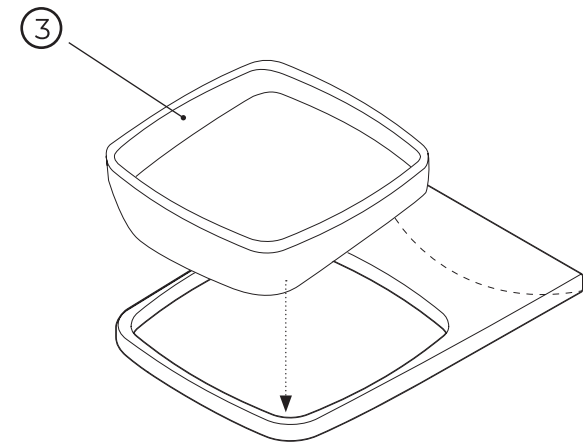
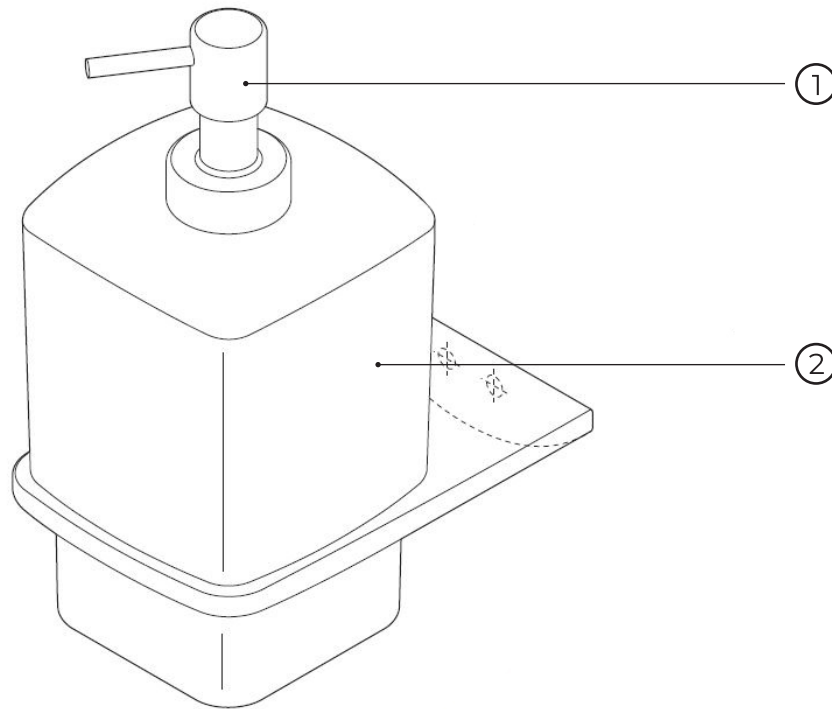

No.	Material code	Name	QTY
1	90403164	Soap dispenser pump	1
2	90403140	Soap dispenser container	1
3	90403240	plastic insert for the holder	1