

kielle

30102005

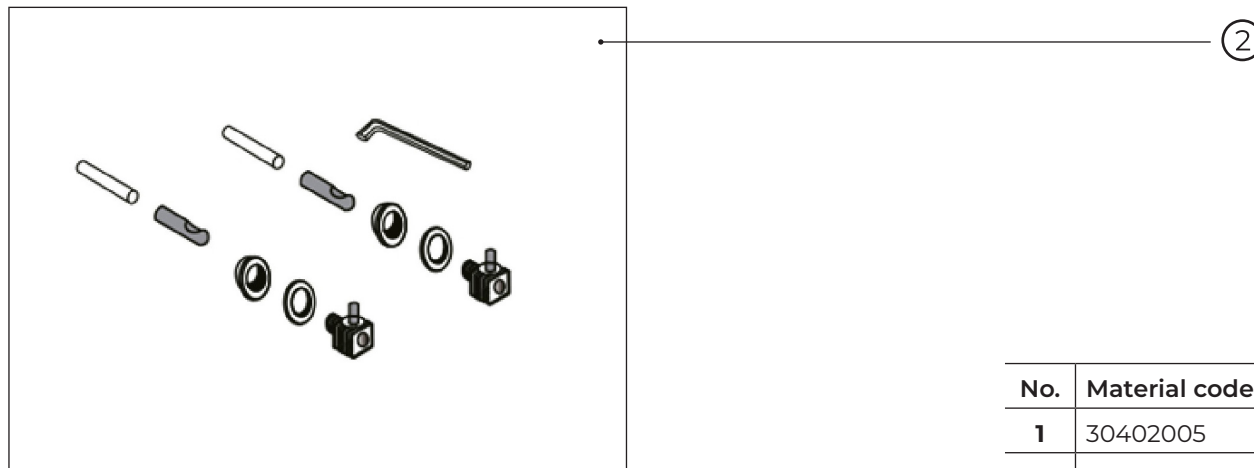
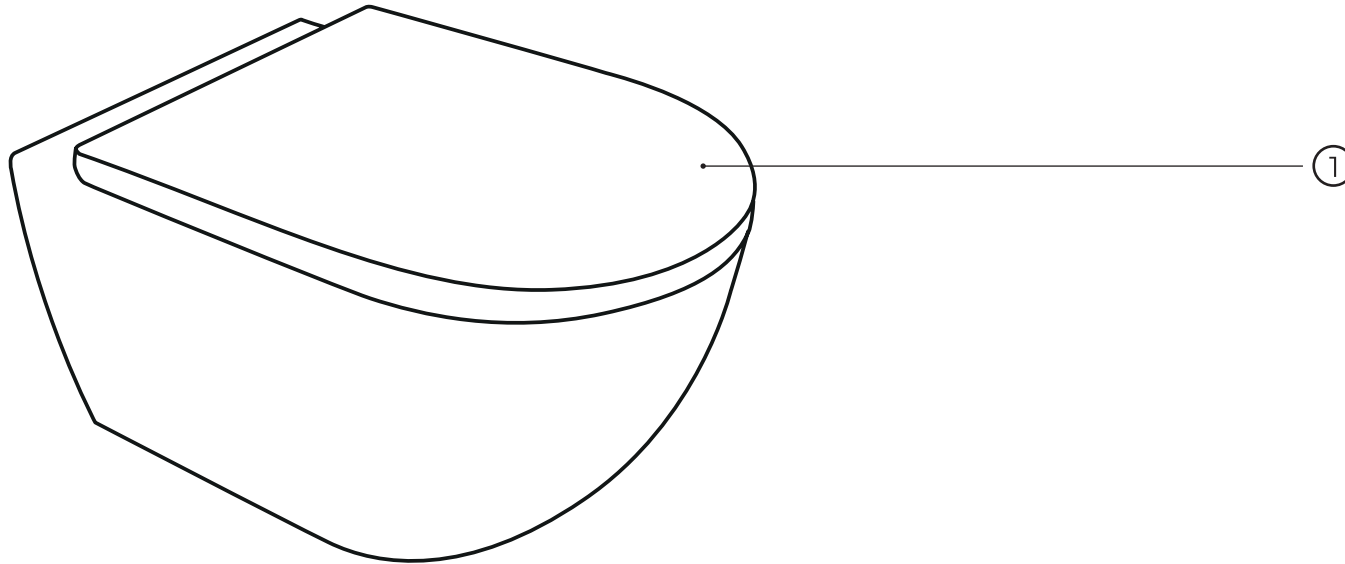

No.	Material code	Name	QTY
1	30402005	seat	1
2	30903001	fixation set	1