

kielle

30102010-SET2

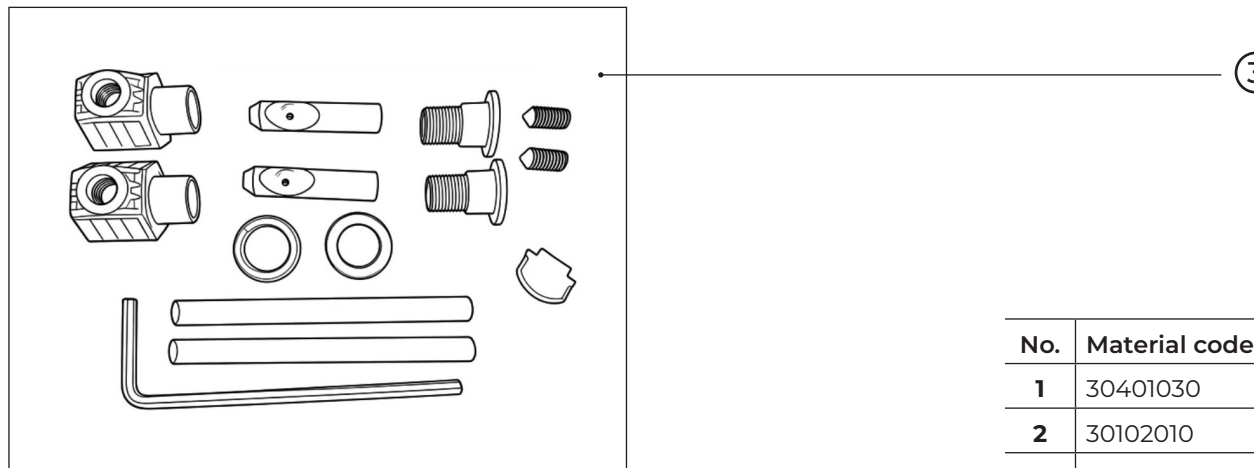
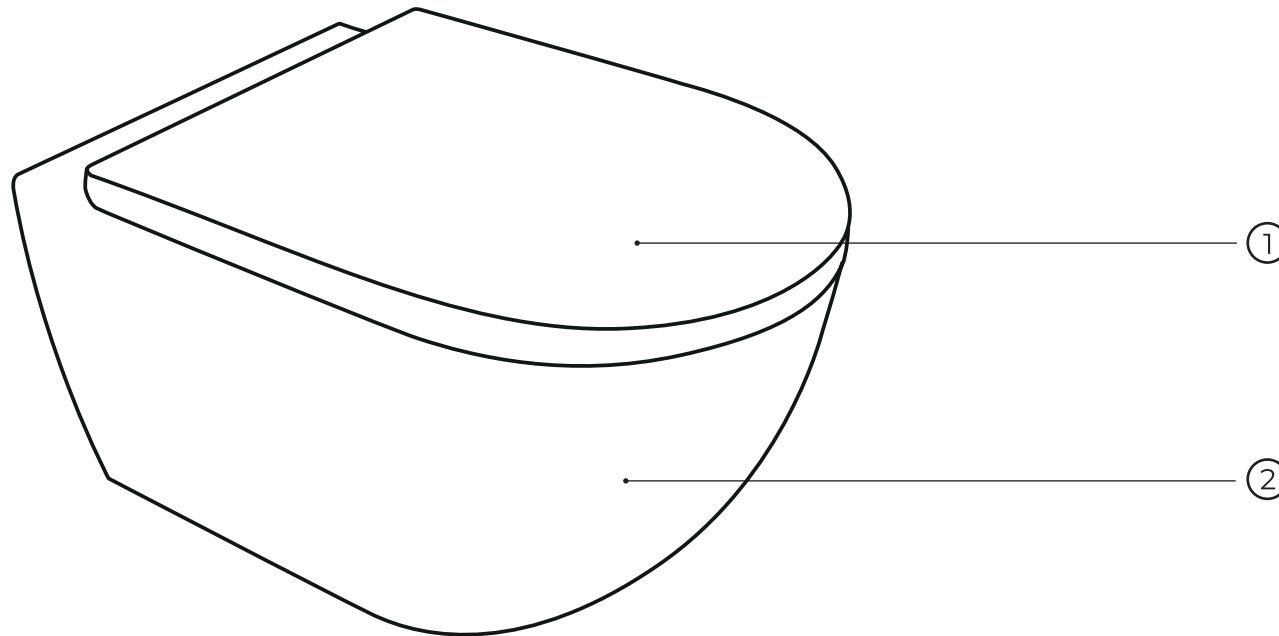

No.	Material code	Name	QTY
1	30401030	seat	1
2	30102010	toilet bowl	1
3	30903002	fixation set	1