

kielle

30102014-SET1

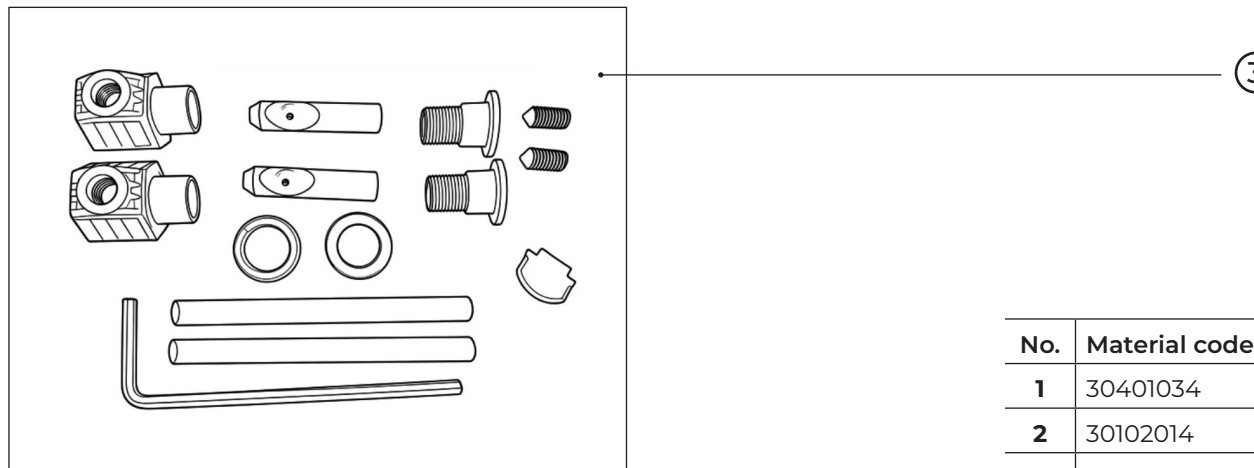
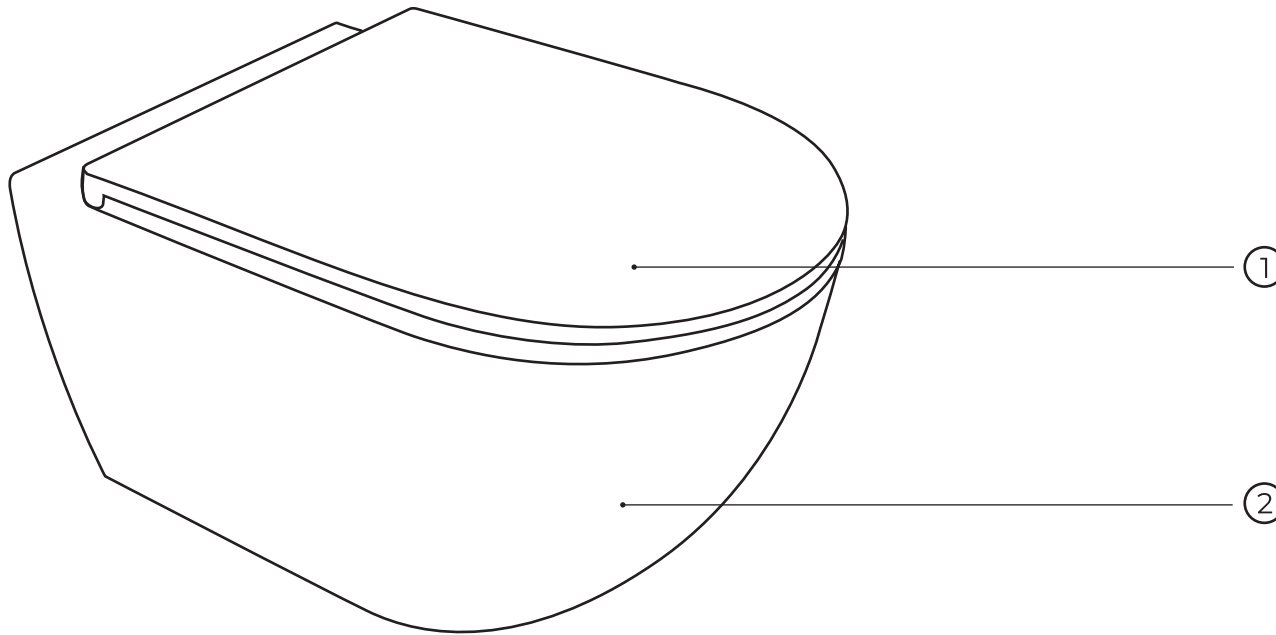

No.	Material code	Name	QTY
1	30401034	seat	1
2	30102014	toilet bowl	1
3	30903002	fixation set	1