

kielle

40118034

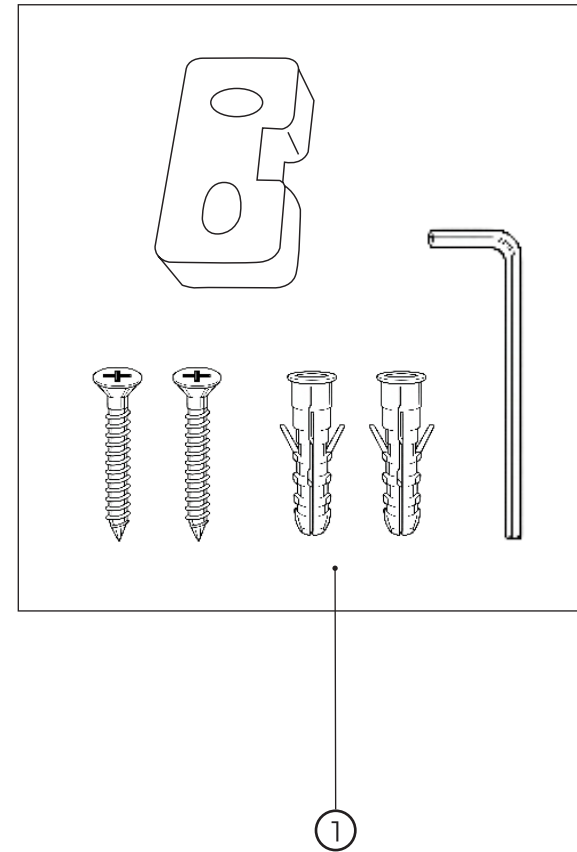
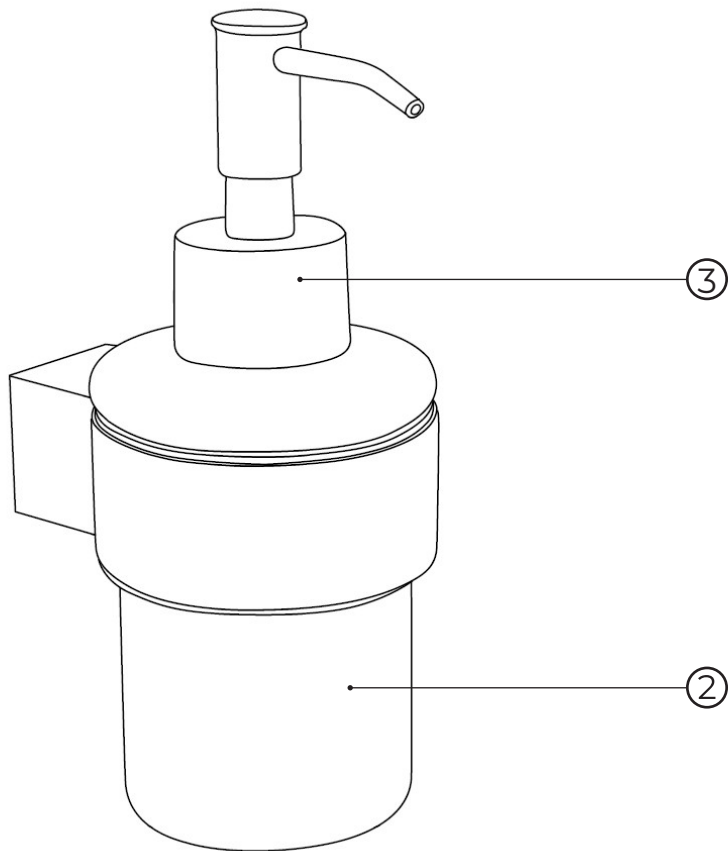

No.	Material code	Name	QTY
1	90403330	Assembly kit	1
2	90403273	Soap dispenser container	1
3	90403294	Soap dispenser pump	1