

kielle

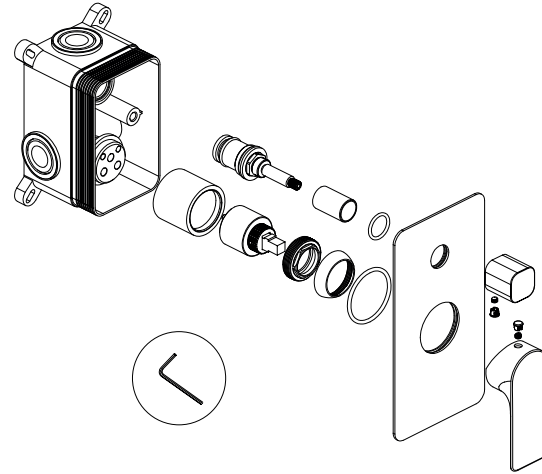

0,5 max. 10

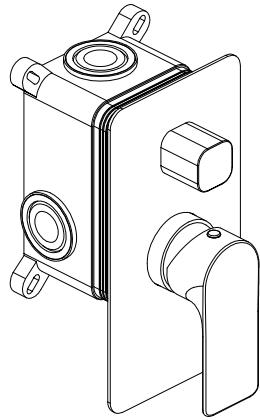
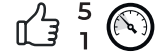

max. 90°C

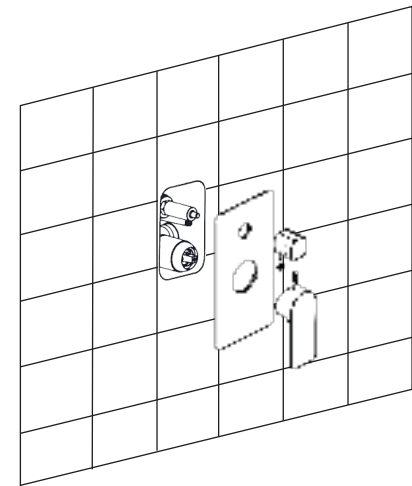
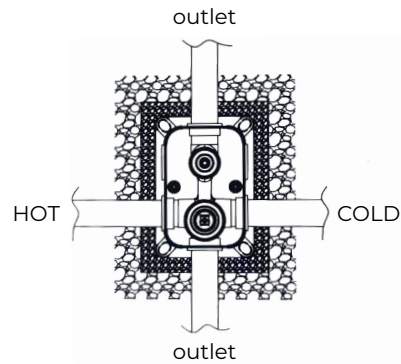
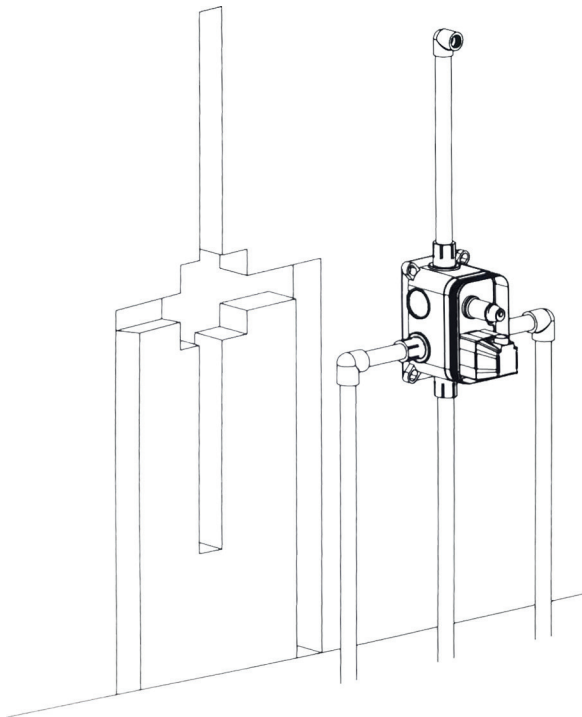

kielle

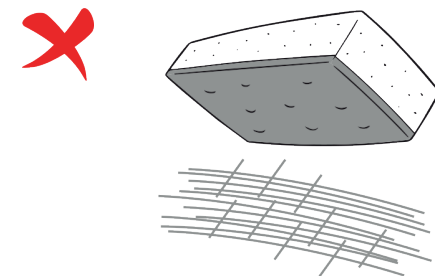
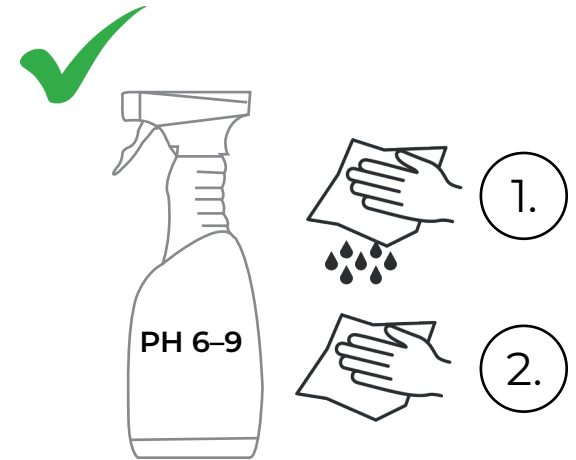
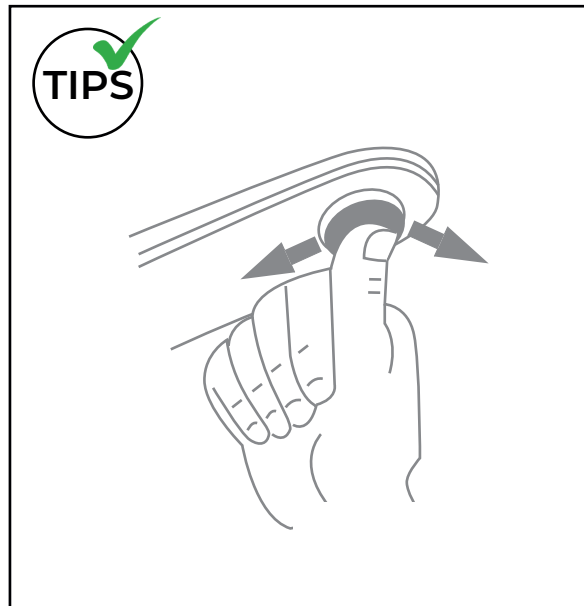
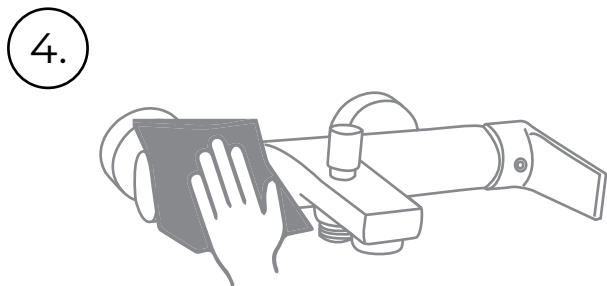
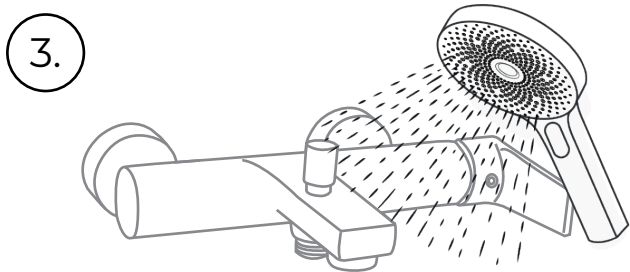
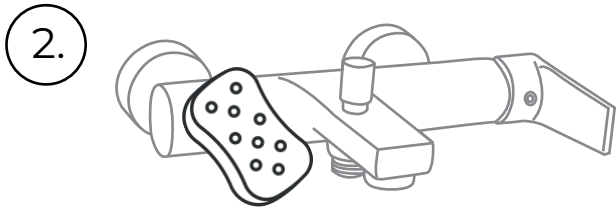
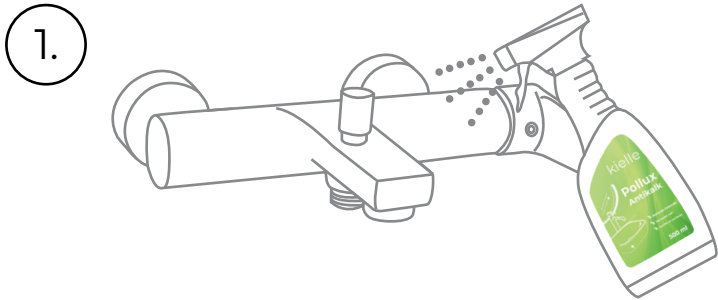

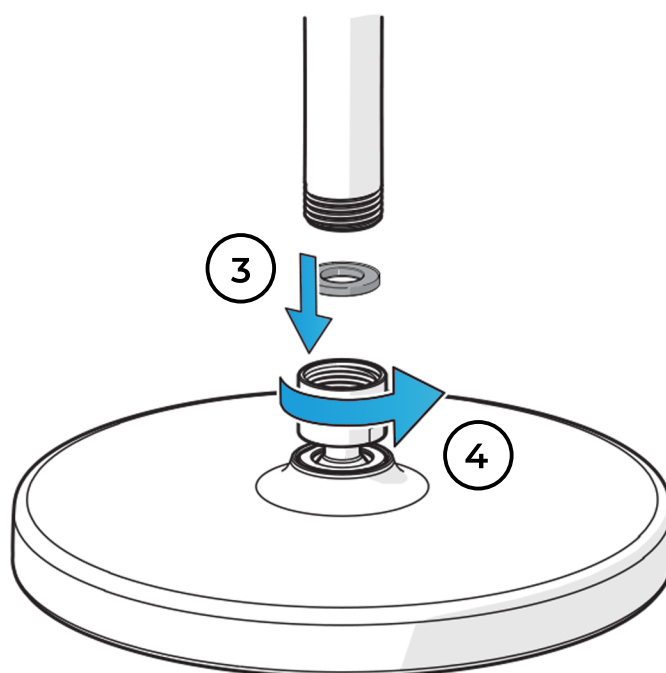
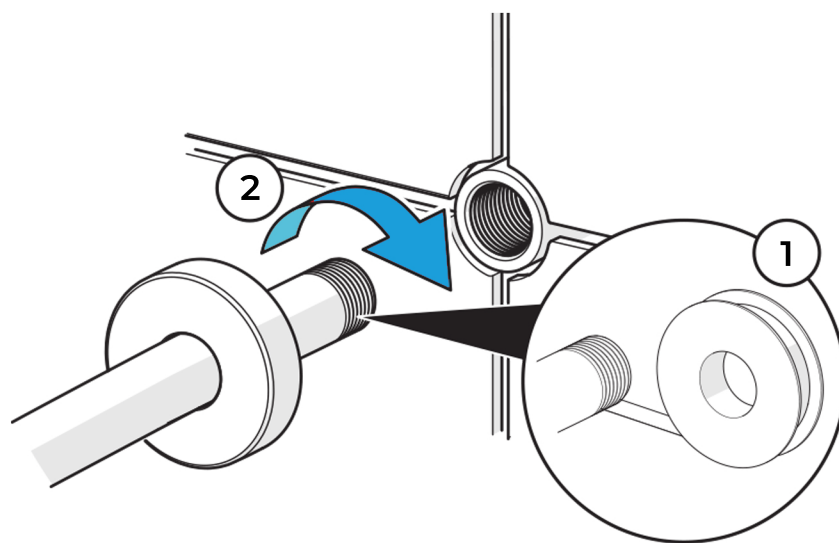

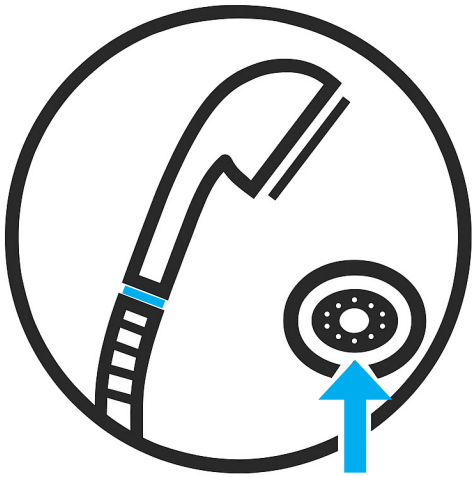

EN Installation manual – flow restriction

The existing washer is removed and replaced with a 6l/min or 9l/min flow limiter. Insert the flow limiter between the shower hose and the shower head with the O-ring or strainer facing downwards.

DE Montageanleitung – Durchflussbegrenzung

Die vorhandene Dichtung wird entfernt und durch einen Durchflussbegrenzer mit 6 l/min oder 9 l/min ersetzt. Setzen Sie den Durchflussbegrenzer mit dem O-Ring oder Sieb nach unten zwischen den Duschschlauch und den Duschkopf ein.

CZ Montážní návod – omezení průtoku

Stávající podložka se odstraní a nahradí se omezovačem na 6 l/min nebo 9 l/min. Omezovač průtoku vložte mezi sprchovou hadici a sprchovou hlavici O-kroužkem nebo sítkem směrem dolů.

SK Návod na montáž – obmedzenie prietoku

Stávajúca podložka sa odstráni a nahradí sa obmedzovačom na 6 l/min alebo 9 l/min. Obmedzovač prietoku vložte medzi sprchovú hadicu a sprchovú hlavicu O-krúžkom alebo sítkom smerom dole.

FR Mode d'emploi – limitation du débit

Le joint existant doit être retiré et remplacé par un limiteur de débit de 6 l/min ou 9 l/min. Insérez le limiteur de débit entre le flexible de douche et le pommeau de douche avec le joint torique ou le filtre orienté vers le bas.

NL Installatie-instructies – doorstromingsbeperkingen

De bestaande afdichtring wordt verwijderd en vervangen door een doorstroombegrenzer van 6 l/min of 9 l/min. Plaats de doorstroombegrenzer tussen de doucheslang en de douchekop, met de O-ring of het zeefje naar beneden gericht.

IT Istruzioni per il montaggio – limitazione del flusso

La guarnizione esistente viene rimossa e sostituita con un limitatore da 6 l/min o 9 l/min. Inserite il limitatore di flusso tra il tubo flessibile della doccia e la doccetta con l'O-ring o il filtro rivolti verso il basso.

ES Instrucciones de montaje – restricción de flujo

Retirar la arandela instalada y sustituir por un limitador de 6 l/min o 9 l/min. Colocar el limitador de caudal entre la manguera de la ducha y el cabezal de ducha con la junta tórica o el tamiz hacia abajo.

RO Instrucțiuni de montaj – restricționarea fluxului

Garnitura existentă se îndepărtează și se înlocuiește cu un limitator de debit de 6 l/min sau 9 l/min. Introduceți limitatorul de debit între furtunul de duș și para de duș, cu O-ring-ul sau sita orientată în jos.

PL Instrukcja montażu – ograniczenie przepływu

Istniejącą podkładkę należy zdemontować i zastąpić ogranicznikiem przepływu 6 l/min lub 9 l/min. Ogranicznik przepływu należy umieścić między węzłem prysznicowym a głowicą prysznicową, z uszczelką typu O lub sitkiem skierowanym w dół.

HU Szerelési útmutató – áramláskorlátozás

A meglévő alátétet el kell távolítani, és 6 l/perc vagy 9 l/perc átfolyáskorlátozóra kell cserélni. Az átfolyáskorlátozót a zuhanytömlő és a zuhanyfej közé kell helyezni, az O-gyűrűvel vagy szűrővel lefelé néző irányban.

Datasheet



flow, stop and go®

PCW-01 1/2" Washer Regulators Metric Flow Rates

PCW-01 1/2" washer regulators are flow regulators with an added sealing function. These water savers are easy to install and fit in any 1/2" connection, making them the perfect retrofit solution for existing shower handles, shattafs or wall/ceiling-mounted shower heads.

The PCW-01 washer regulator must be tightened with a torque of 2 Nm max. Observe the direction of flow.

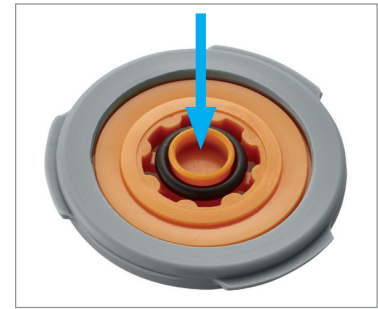

PCW-01 1/2" washer regulator

Materials used

Housing: POM
O-ring: EPDM
PCW washer: silicone

Model Overview

PCW-01 Washer Regulators

Model / Flow rate	Color Code	Part no. PCW-01	Flow tolerance (in %)	Pressure range (in bar)
PCW-01 1/2" 2.0 l/min.	olive	58.8632.100	+30 / -30	1.0 - 10.0
PCW-01 1/2" 3.0 l/min.	brown	58.8633.100	+30 / -30	1.0 - 10.0
PCW-01 1/2" 4.0 l/min.	dark grey	58.8634.100	+20 / -20	1.0 - 10.0
PCW-01 1/2" 5.0 l/min.	yellow	58.8635.100	+20 / -20	1.0 - 10.0
PCW-01 1/2" 6.0 l/min.	black	58.8636.100	+10 / -10	1.0 - 10.0
PCW-01 1/2" 7.0 l/min.	light green	58.8637.100	+10 / -10	1.0 - 10.0
PCW-01 1/2" 8.0 l/min.	natural white	58.8638.100	+10 / -10	1.0 - 10.0
PCW-01 1/2" 9.0 l/min.	orange	58.8639.100	+10 / -10	1.5 - 10.0
PCW-01 1/2" 10.0 l/min.	light blue	58.8640.100	+10 / -10	1.5 - 10.0
PCW-01 1/2" 11.0 l/min.	brown	58.8641.100	+10 / -10	1.0 - 10.0
PCW-01 1/2" 12.0 l/min.	red	58.8642.100	+10 / -10	1.5 - 10.0
PCW-01 1/2" 15.0 l/min.	lime green	58.8650.100	+10 / -10	3.0 - 10.0

Flow Curves

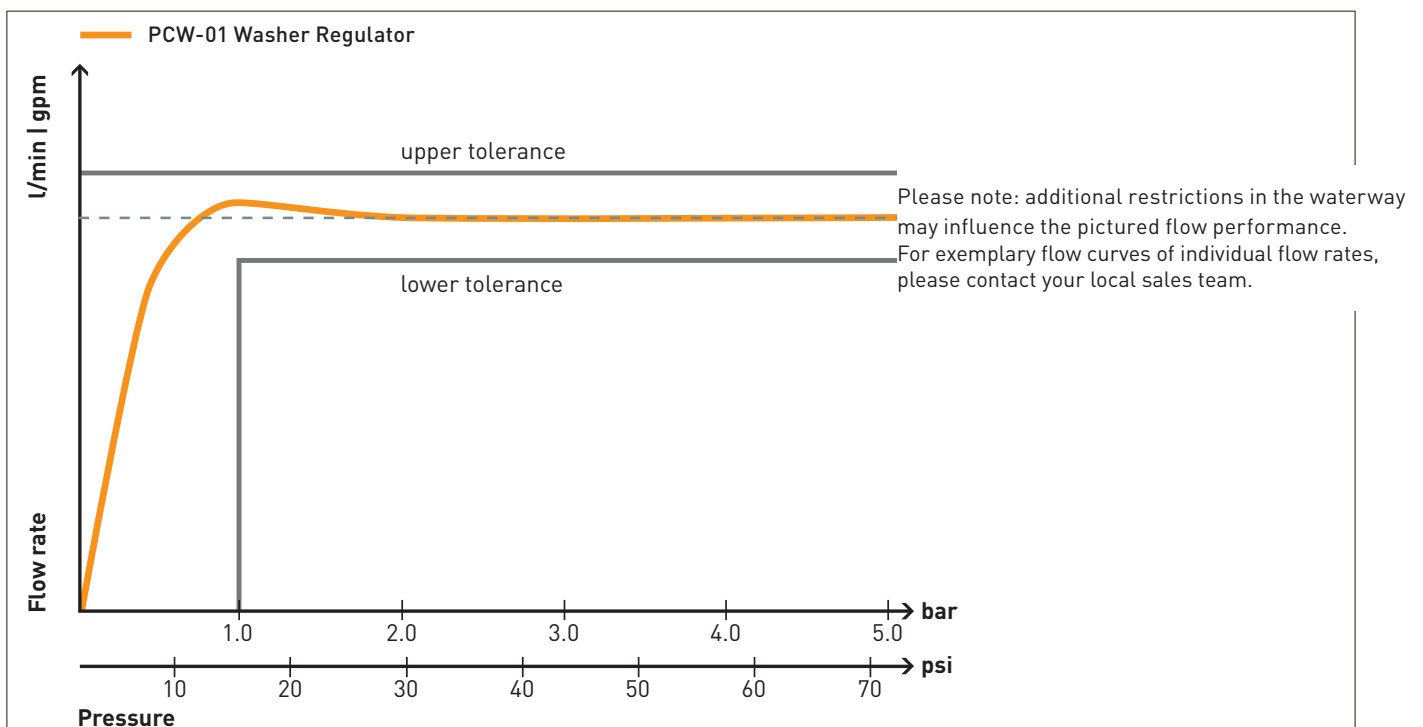

Datasheet



PCW-01 1/2" Washer Regulators Metric Flow Rates

flow, stop and go®

Dimensions (in mm)

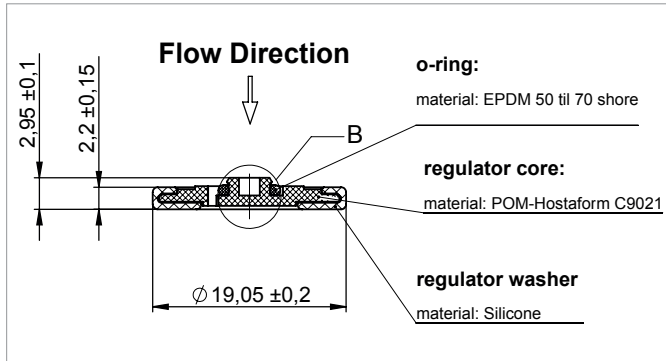

PCW-01 1/2" washer regulator

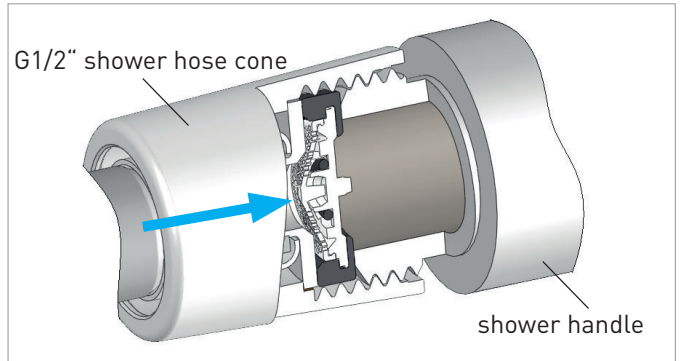

Recommended mounting position for shower handles

Intended Use



Drinking water only

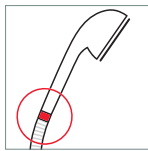

Shower handles

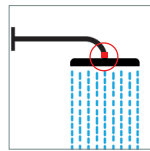

Shower heads

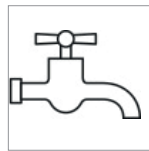

Bib taps/
wall spouts

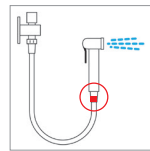

Shattafs/
bidet showers

Assembly Instructions

ATTENTION!

Product may not be altered!
May not be used for hot water application exceeding 70°C

ATTENTION!

Max. mounting torque 2.0 Nm

Operating Conditions

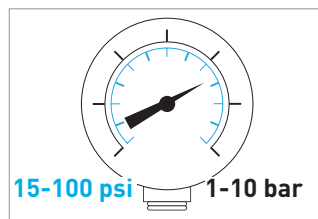
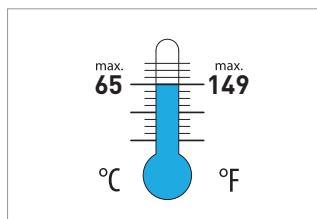

Indicated pressure values refer to supply line pressure.
Avoid water hammer.

kielle

2.

3.

4.

1.

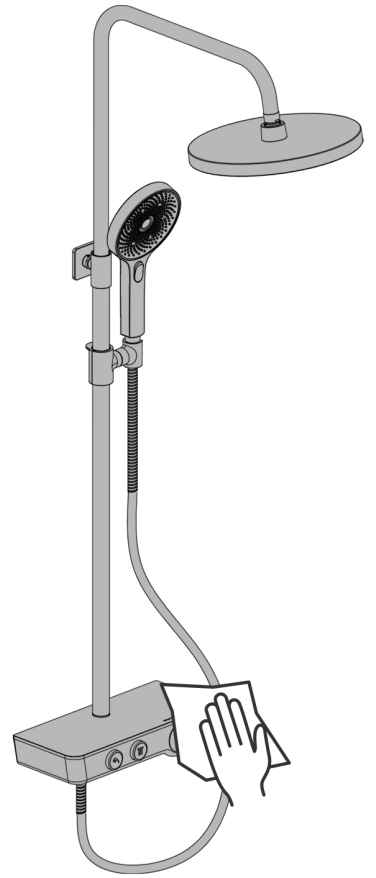
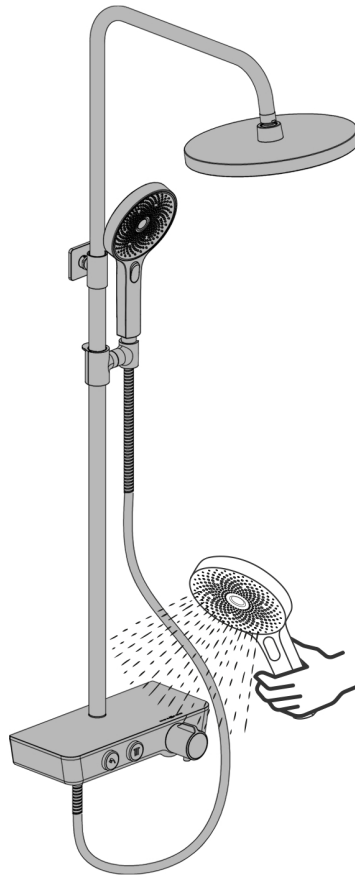
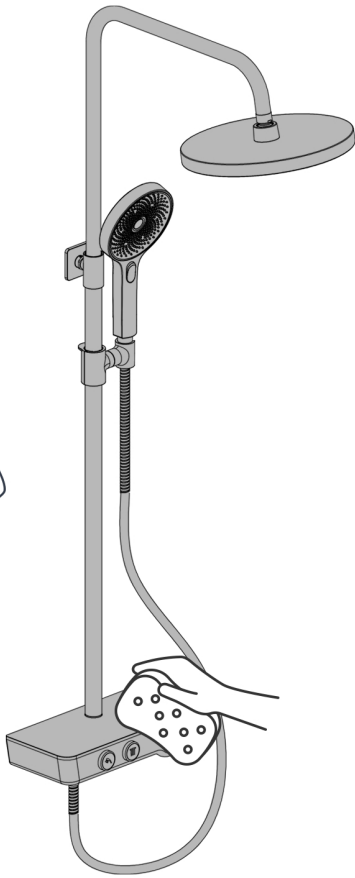

1.



2.

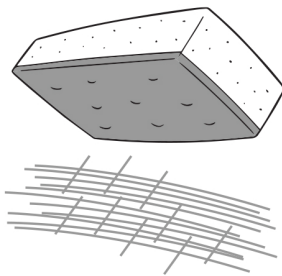

TIPS

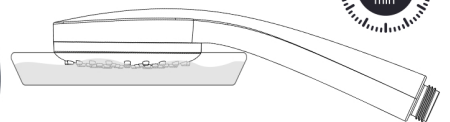
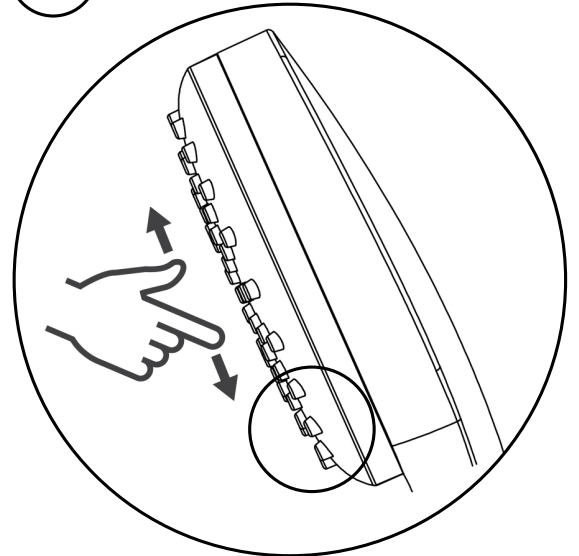

10 min

kielle

kielle GmbH,
Südwestkorso 14,
12161 Berlin, DE
www.kielle.de

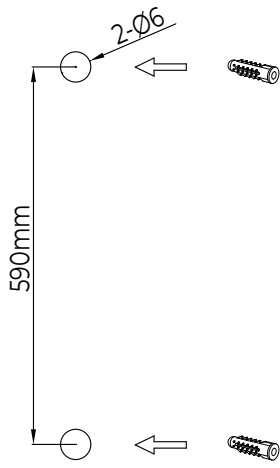
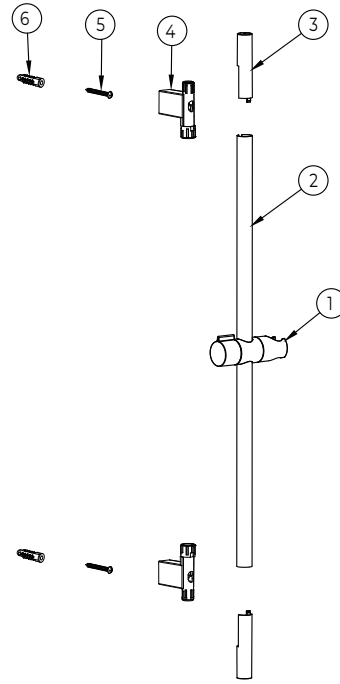
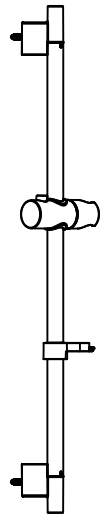

1.

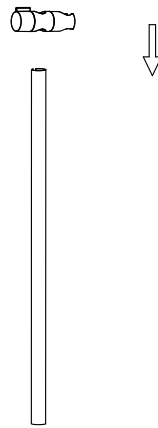

2.

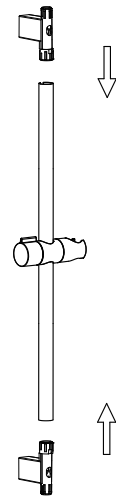

3.

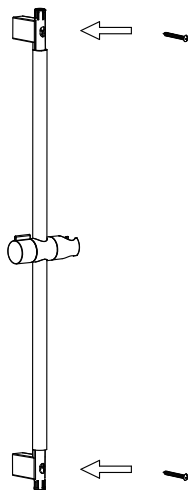

4.

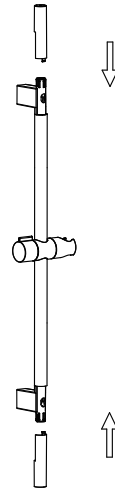

5.

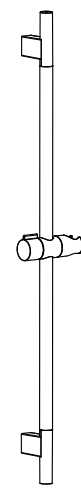

6.

kielle

2.

3.

4.

1.

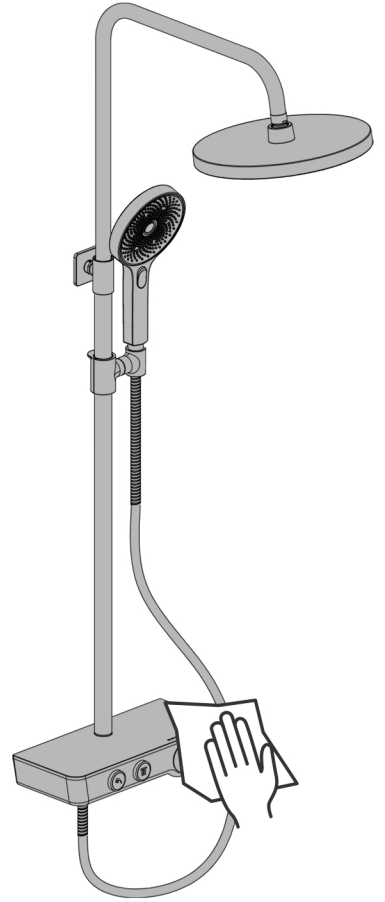
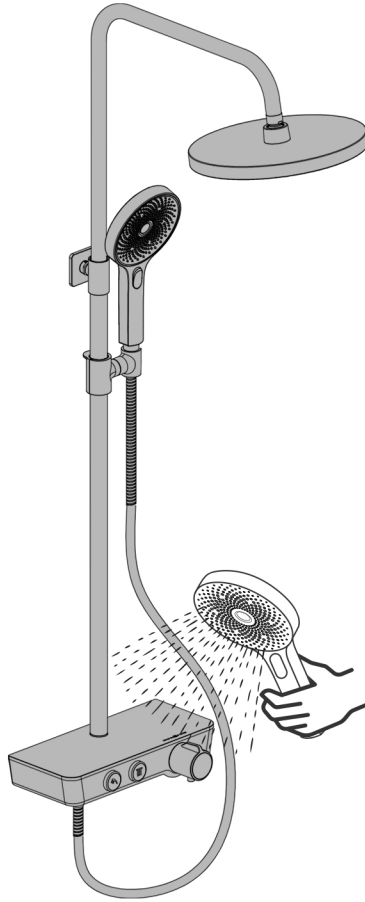
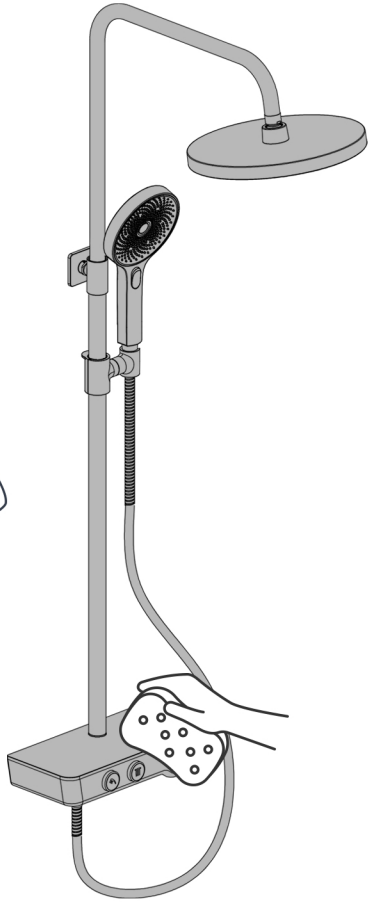

1.



2.

TIPS

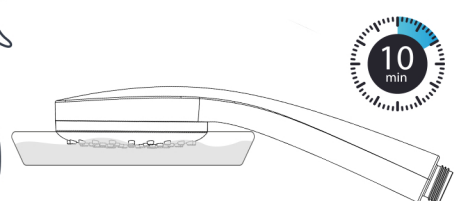
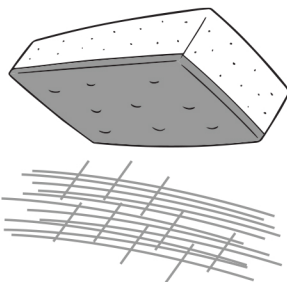
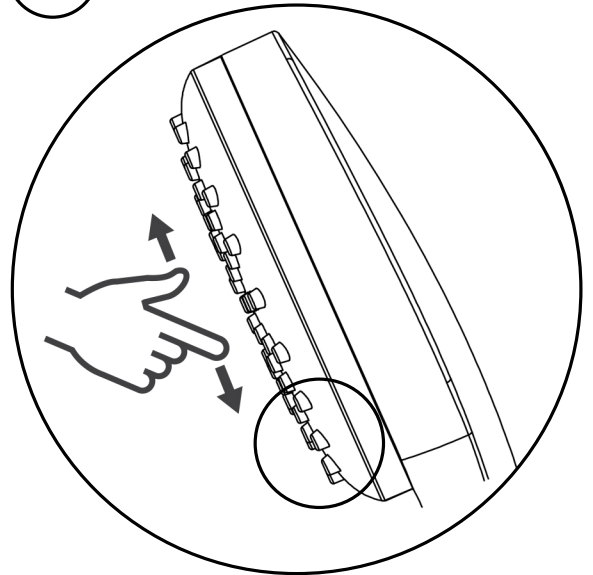

kielle

kielle GmbH
Südwestkorso 14
12161 Berlin, DE
www.kielle.de

