

1.

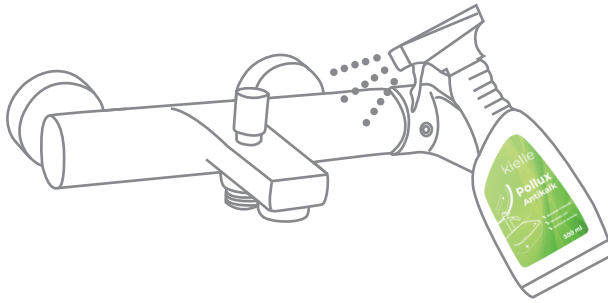

2.

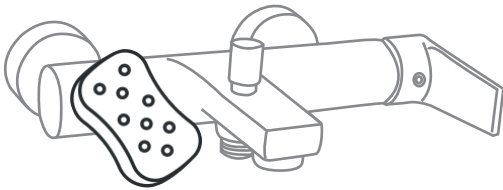

3.

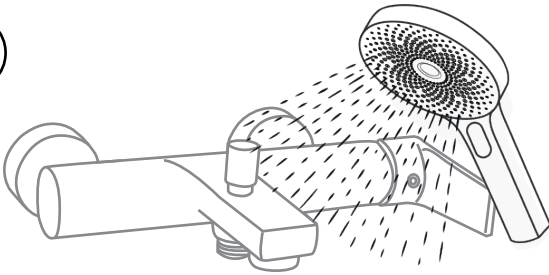

4.

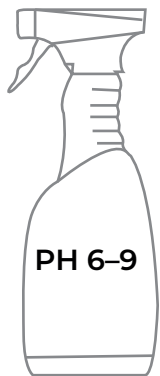
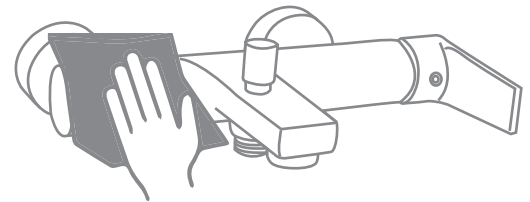

1.



2.

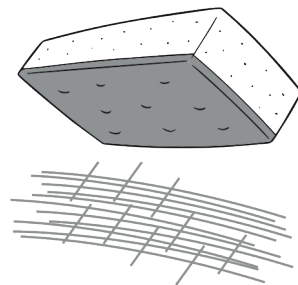

TIPS

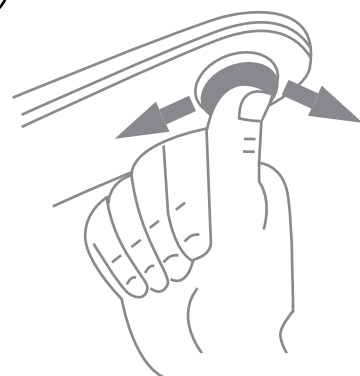

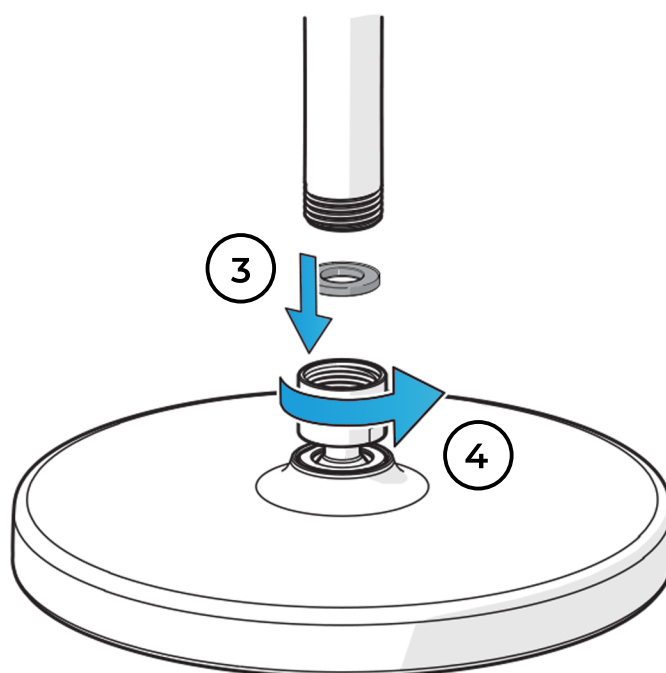
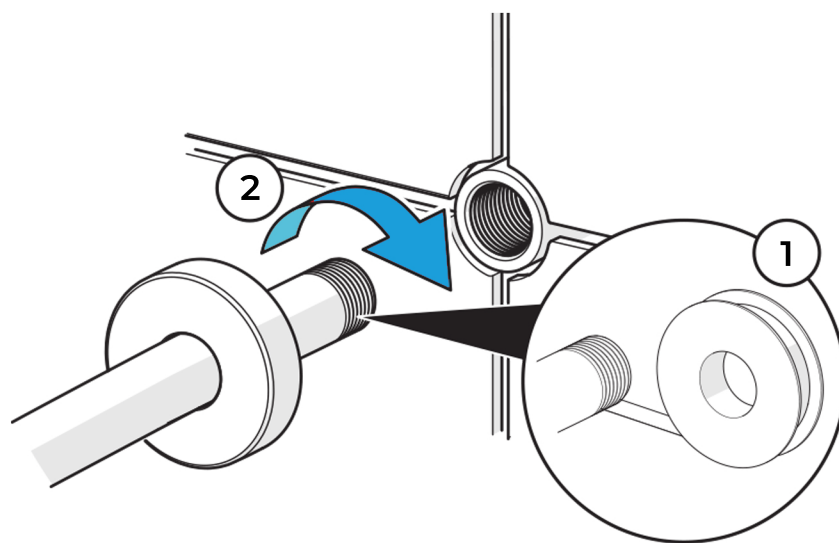

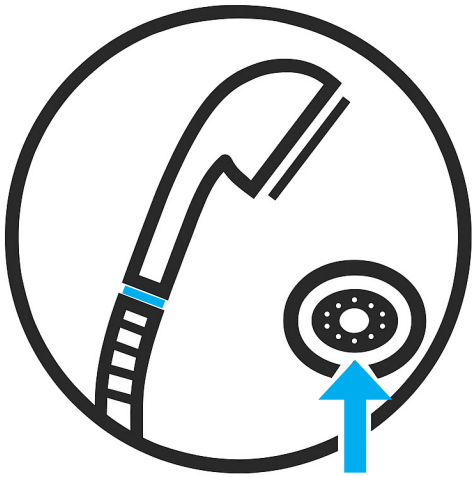

## **EN** Installation manual – flow restriction

The existing washer is removed and replaced with a 6l/min or 9l/min flow limiter. Insert the flow limiter between the shower hose and the shower head with the O-ring or strainer facing downwards.

## **DE** Montageanleitung – Durchflussbegrenzung

Die vorhandene Dichtung wird entfernt und durch einen Durchflussbegrenzer mit 6 l/min oder 9 l/min ersetzt. Setzen Sie den Durchflussbegrenzer mit dem O-Ring oder Sieb nach unten zwischen den Duschschlauch und den Duschkopf ein.

## **CZ** Montážní návod – omezení průtoku

Stávající podložka se odstraní a nahradí se omezovačem na 6 l/min nebo 9 l/min. Omezovač průtoku vložte mezi sprchovou hadici a sprchovou hlavici O-kroužkem nebo sítkem směrem dolů.

## **SK** Návod na montáž – obmedzenie prietoku

Stávajúca podložka sa odstráni a nahradí sa obmedzovačom na 6 l/min alebo 9 l/min. Obmedzovač prietoku vložte medzi sprchovú hadicu a sprchovú hlavicu O-krúžkom alebo sítkom smerom dole.

## **FR** Mode d'emploi – limitation du débit

Le joint existant doit être retiré et remplacé par un limiteur de débit de 6 l/min ou 9 l/min. Insérez le limiteur de débit entre le flexible de douche et le pommeau de douche avec le joint torique ou le filtre orienté vers le bas.

## **NL** Installatie-instructies – doorstromingsbeperkingen

De bestaande afdichtring wordt verwijderd en vervangen door een doorstroombegrenzer van 6 l/min of 9 l/min. Plaats de doorstroombegrenzer tussen de doucheslang en de douchekop, met de O-ring of het zeefje naar beneden gericht.

## **IT** Istruzioni per il montaggio – limitazione del flusso

La guarnizione esistente viene rimossa e sostituita con un limitatore da 6 l/min o 9 l/min. Inserite il limitatore di flusso tra il tubo flessibile della doccia e la doccetta con l'O-ring o il filtro rivolti verso il basso.

## **ES** Instrucciones de montaje – restricción de flujo

Retirar la arandela instalada y sustituir por un limitador de 6 l/min o 9 l/min. Colocar el limitador de caudal entre la manguera de la ducha y el cabezal de ducha con la junta tórica o el tamiz hacia abajo.

## **RO** Instrucțiuni de montaj – restricționarea fluxului

Garnitura existentă se îndepărtează și se înlocuiește cu un limitator de debit de 6 l/min sau 9 l/min. Introduceți limitatorul de debit între furtunul de duș și para de duș, cu O-ring-ul sau sita orientată în jos.

## **PL** Instrukcja montażu – ograniczenie przepływu

Istniejącą podkładkę należy zdemontować i zastąpić ogranicznikiem przepływu 6 l/min lub 9 l/min. Ogranicznik przepływu należy umieścić między węzłem prysznicowym a głowicą prysznicową, z uszczelką typu O lub sitkiem skierowanym w dół.

## **HU** Szerelési útmutató – áramláskorlátozás

A meglévő alátétet el kell távolítani, és 6 l/perc vagy 9 l/perc átfolyáskorlátozóra kell cserélni. Az átfolyáskorlátozót a zuhanytömlő és a zuhanyfej közé kell helyezni, az O-gyűrűvel vagy szűrővel lefelé néző irányban.

# Datasheet



flow, stop and go®

## PCW-01 1/2" Washer Regulators Metric Flow Rates

PCW-01 1/2" washer regulators are flow regulators with an added sealing function. These water savers are easy to install and fit in any 1/2" connection, making them the perfect retrofit solution for existing shower handles, shattafs or wall/ceiling-mounted shower heads.

The PCW-01 washer regulator must be tightened with a torque of 2 Nm max. Observe the direction of flow.

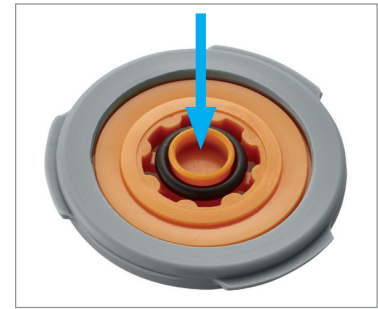

PCW-01 1/2" washer regulator

### Materials used

Housing: POM  
O-ring: EPDM  
PCW washer: silicone

## Model Overview

### PCW-01 Washer Regulators

Model / Flow rate	Color Code	Part no. PCW-01	Flow tolerance (in %)	Pressure range (in bar)
PCW-01 1/2" 2.0 l/min.	olive	58.8632.100	+30 / -30	1.0 - 10.0
PCW-01 1/2" 3.0 l/min.	brown	58.8633.100	+30 / -30	1.0 - 10.0
PCW-01 1/2" 4.0 l/min.	dark grey	58.8634.100	+20 / -20	1.0 - 10.0
PCW-01 1/2" 5.0 l/min.	yellow	58.8635.100	+20 / -20	1.0 - 10.0
PCW-01 1/2" 6.0 l/min.	black	58.8636.100	+10 / -10	1.0 - 10.0
PCW-01 1/2" 7.0 l/min.	light green	58.8637.100	+10 / -10	1.0 - 10.0
PCW-01 1/2" 8.0 l/min.	natural white	58.8638.100	+10 / -10	1.0 - 10.0
PCW-01 1/2" 9.0 l/min.	orange	58.8639.100	+10 / -10	1.5 - 10.0
PCW-01 1/2" 10.0 l/min.	light blue	58.8640.100	+10 / -10	1.5 - 10.0
PCW-01 1/2" 11.0 l/min.	brown	58.8641.100	+10 / -10	1.0 - 10.0
PCW-01 1/2" 12.0 l/min.	red	58.8642.100	+10 / -10	1.5 - 10.0
PCW-01 1/2" 15.0 l/min.	lime green	58.8650.100	+10 / -10	3.0 - 10.0

## Flow Curves

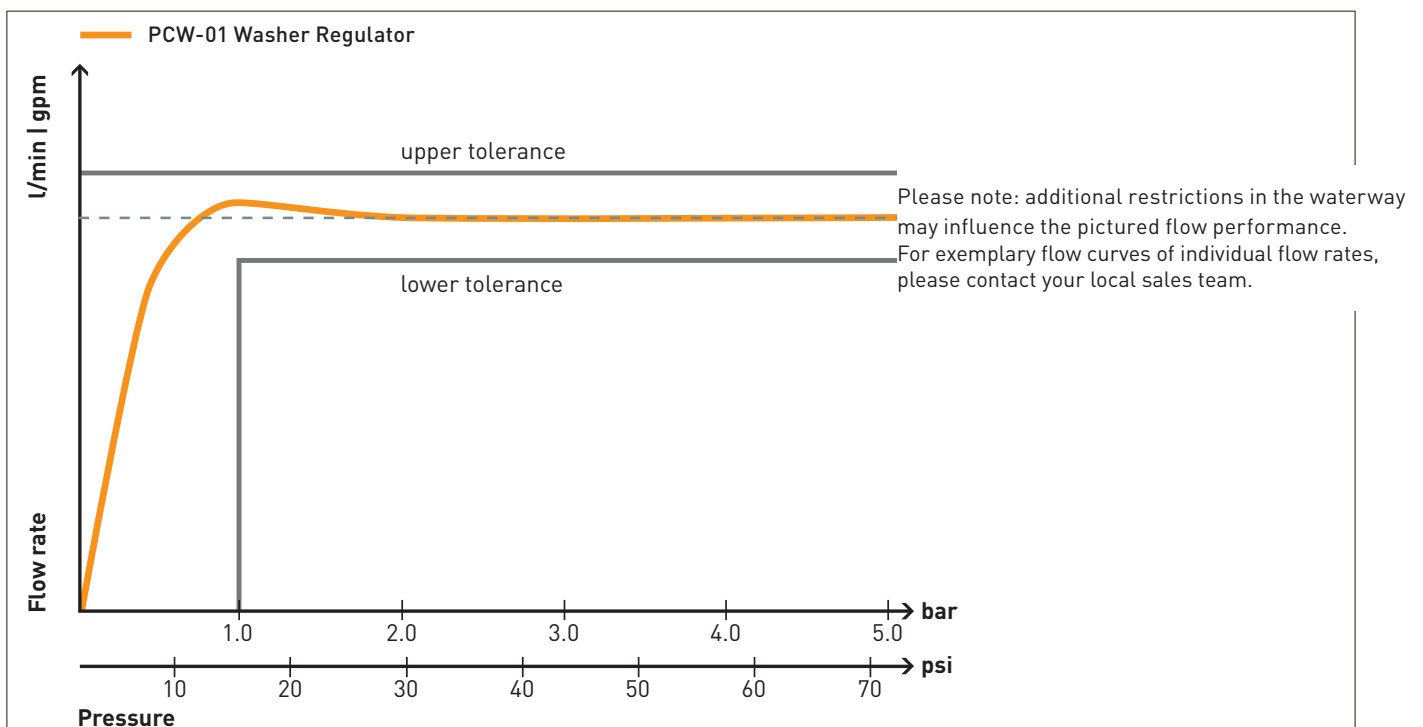

# Datasheet



## PCW-01 1/2" Washer Regulators Metric Flow Rates

flow, stop and go®

### Dimensions (in mm)

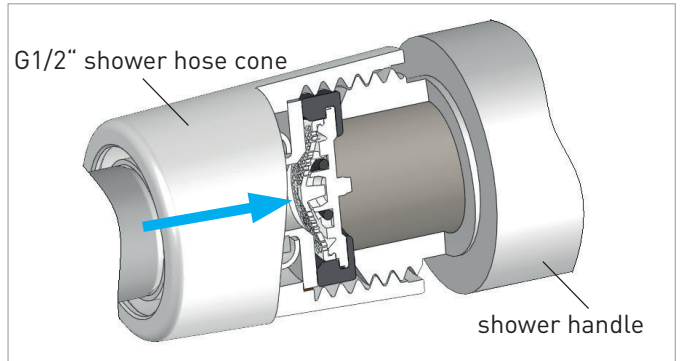
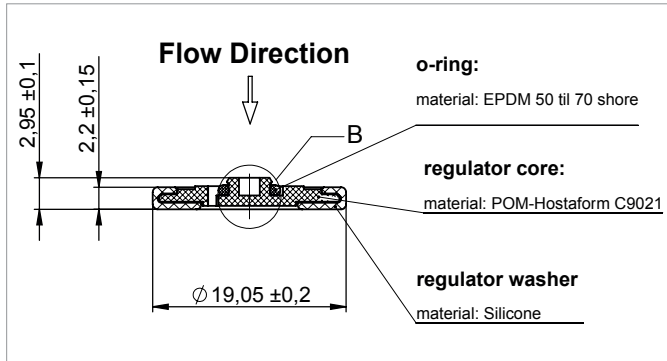

PCW-01 1/2" washer regulator

Recommended mounting position for shower handles

### Intended Use



Drinking water only

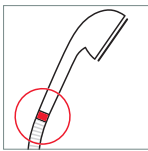

Shower handles

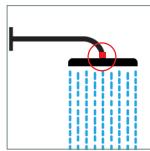

Shower heads

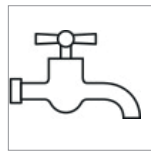

Bib taps/  
wall spouts

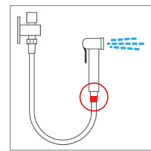

Shattafs/  
bidet showers

### Assembly Instructions

#### ATTENTION!

Product may not be altered!  
May not be used for hot water application exceeding 70°C

#### ATTENTION!

Max. mounting torque 2.0 Nm

### Operating Conditions

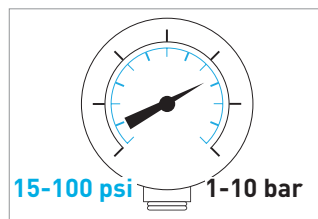
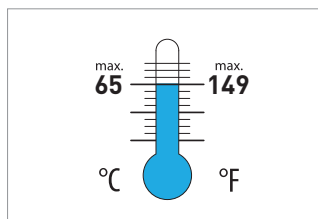

Indicated pressure values refer to supply line pressure.  
Avoid water hammer.

# kielle

2.

3.

4.

1.

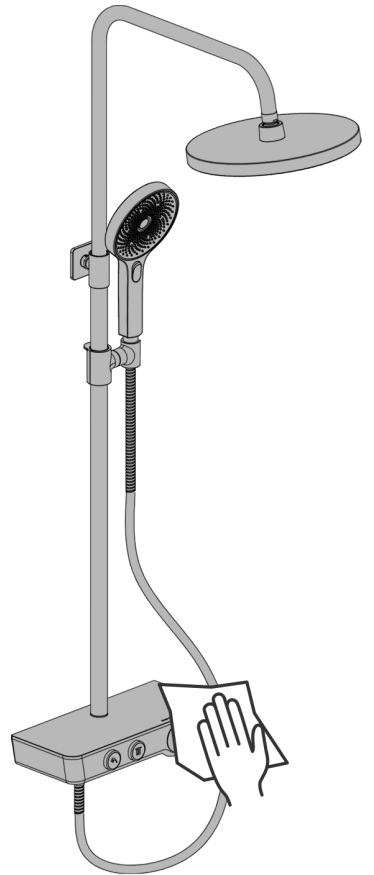
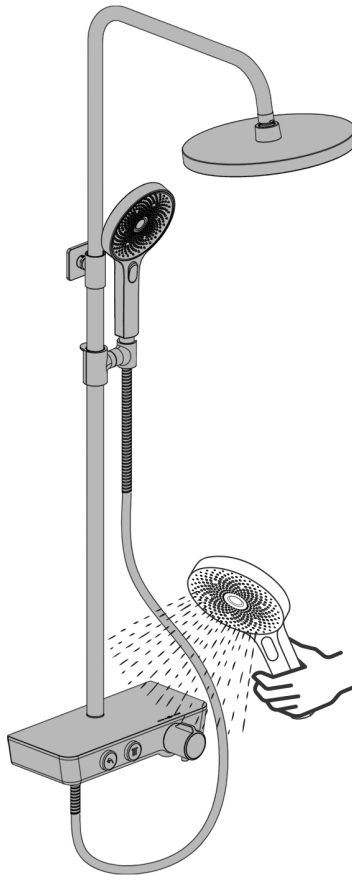
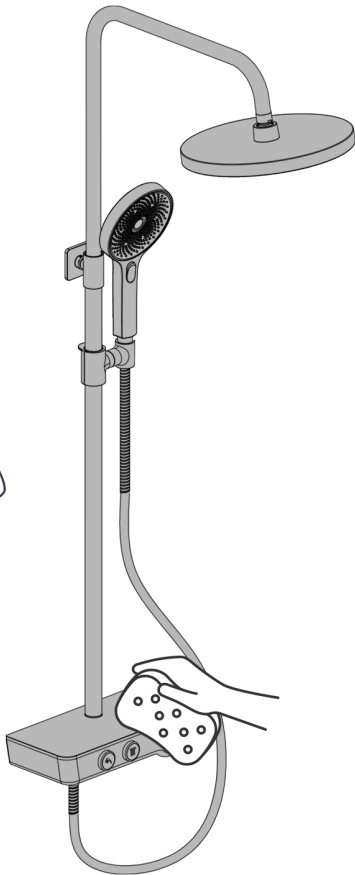

1.



2.

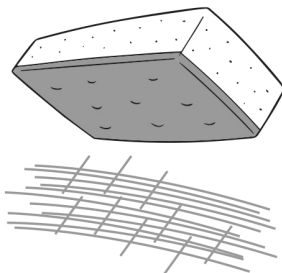

TIPS

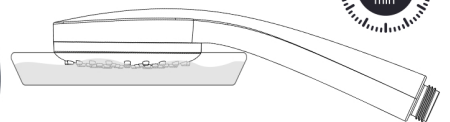
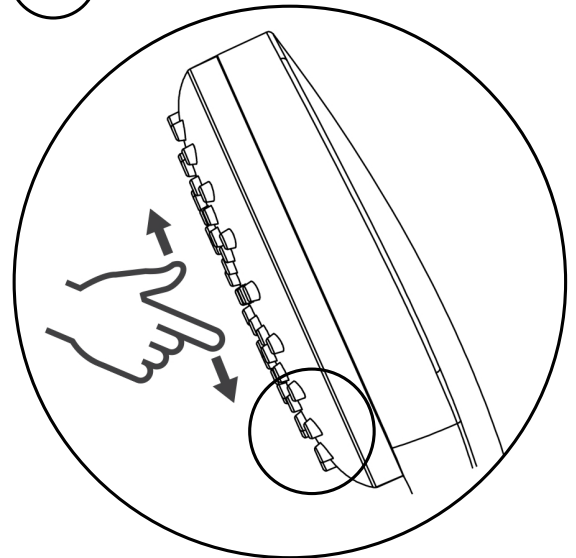

# kielle

kielle GmbH,  
Südwestkorso 14,  
12161 Berlin, DE  
[www.kielle.de](http://www.kielle.de)

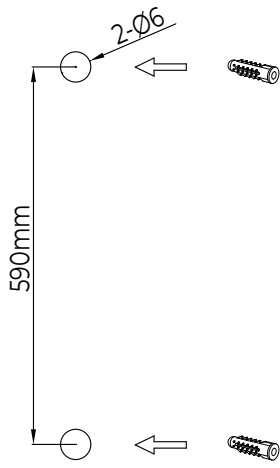
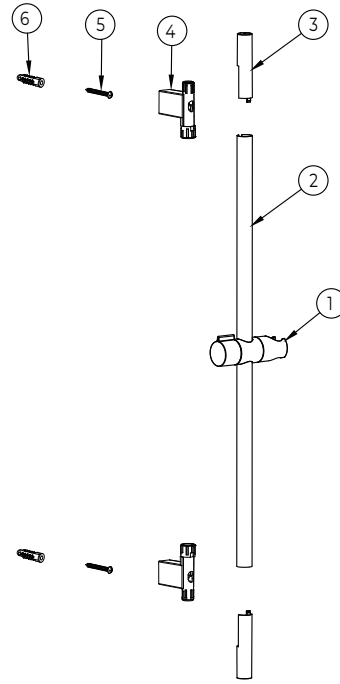
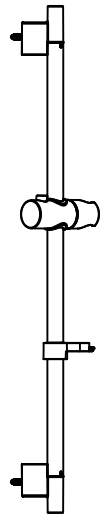

1.

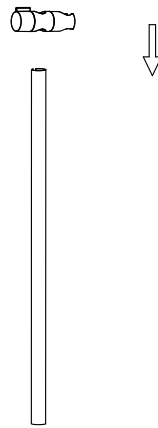

2.

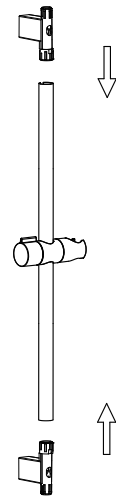

3.

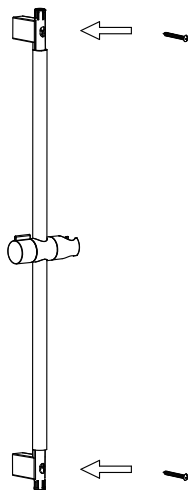

4.

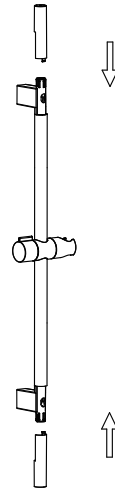

5.

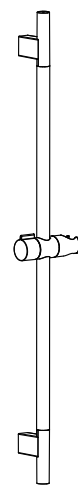

6.

# kielle

2.

3.

4.

1.

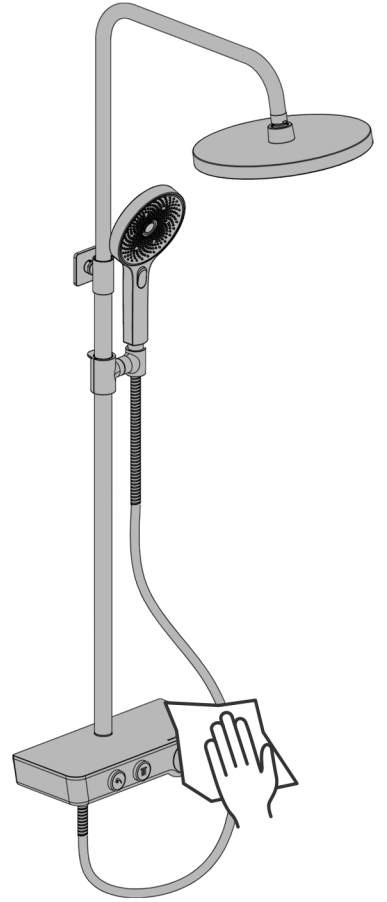
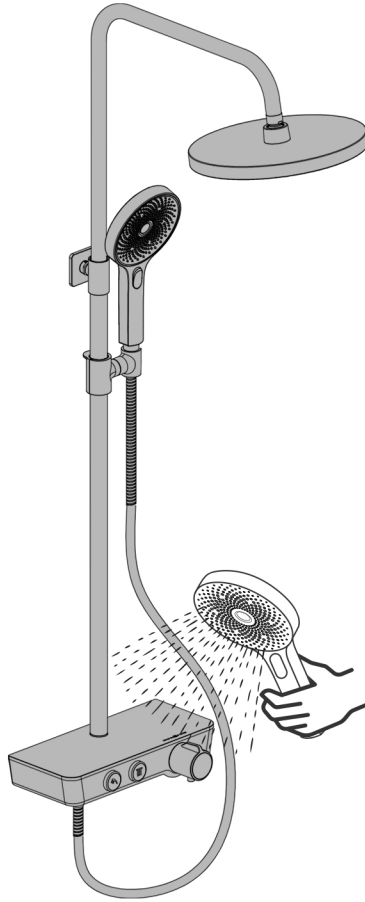
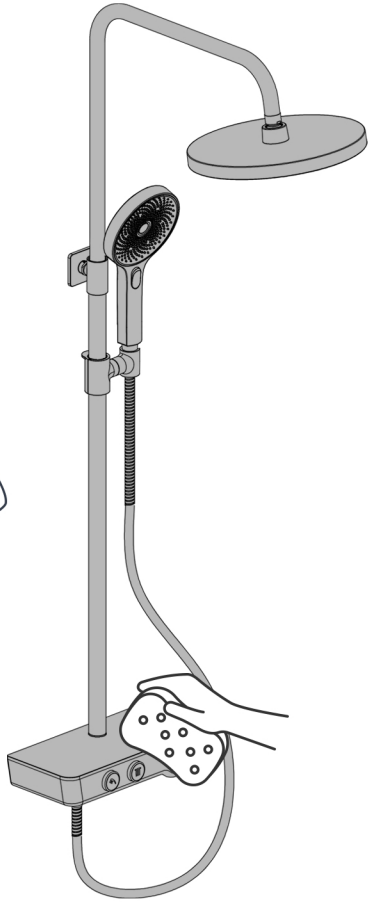

1.



2.

TIPS

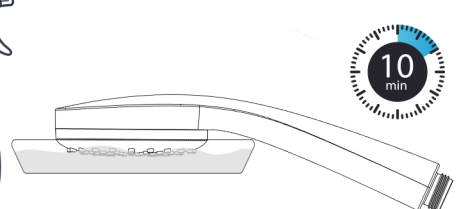
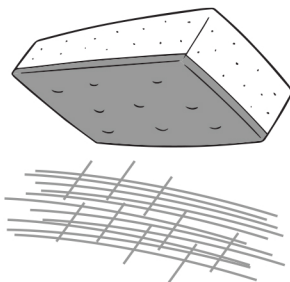
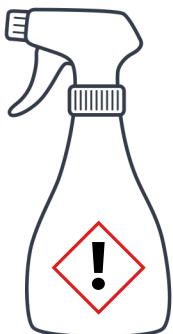
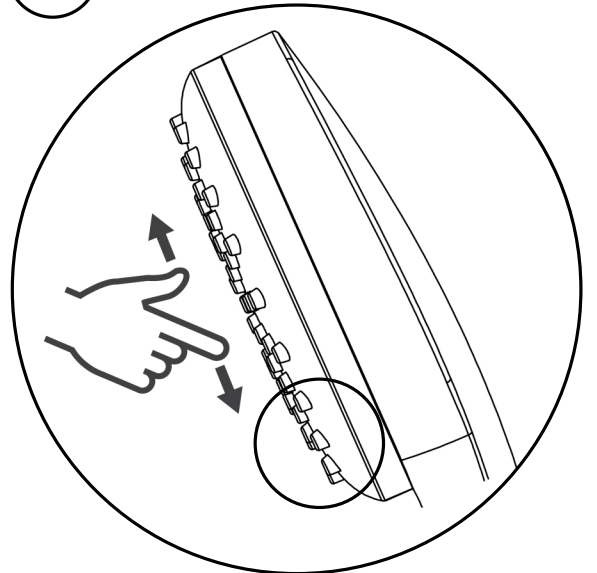

10 min

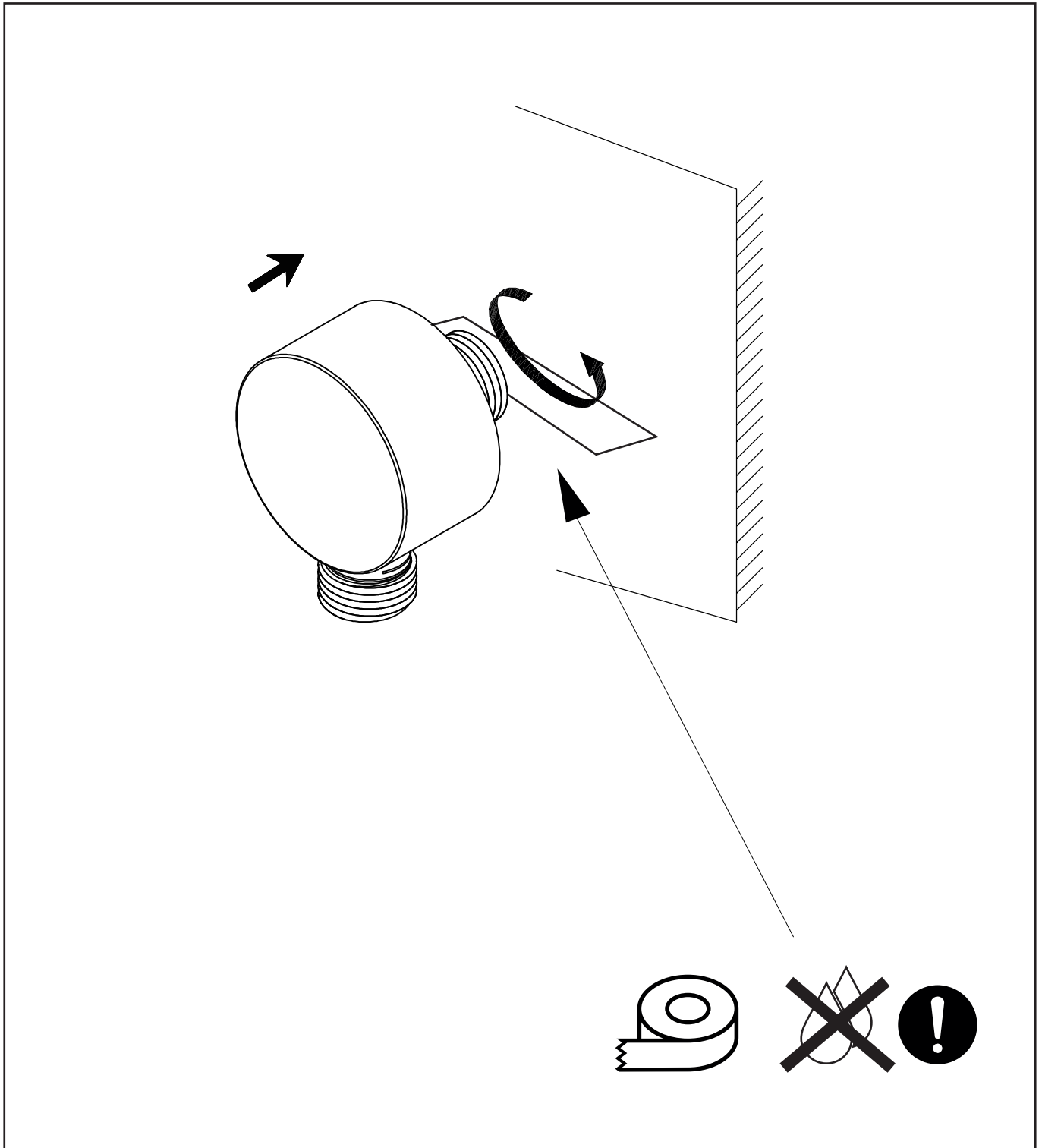

# kielle

2.

3.

4.

1.

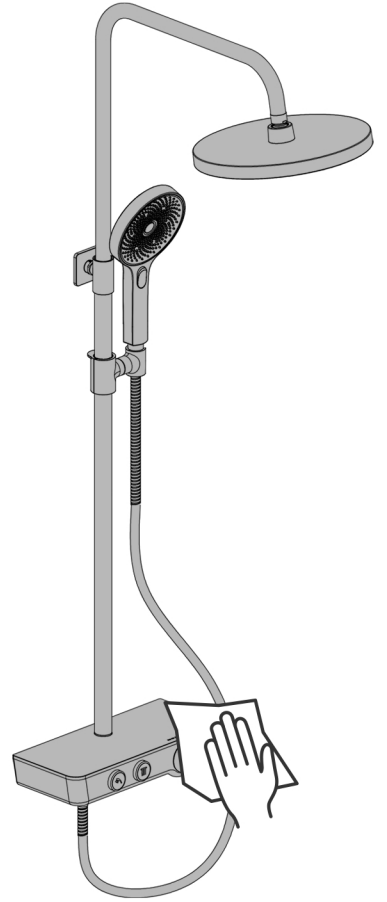
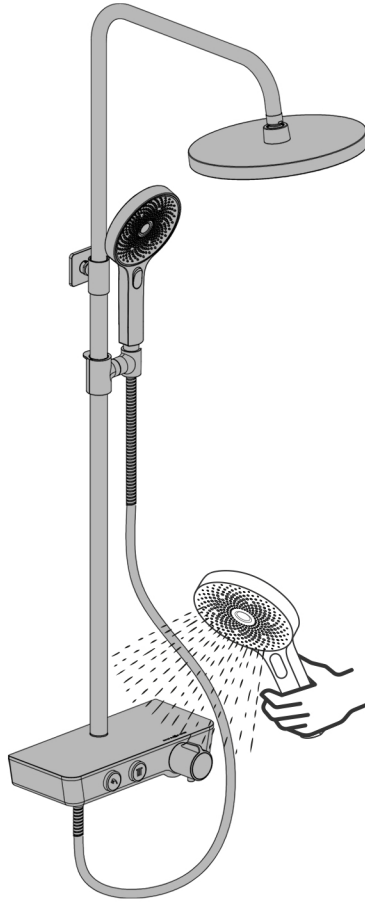
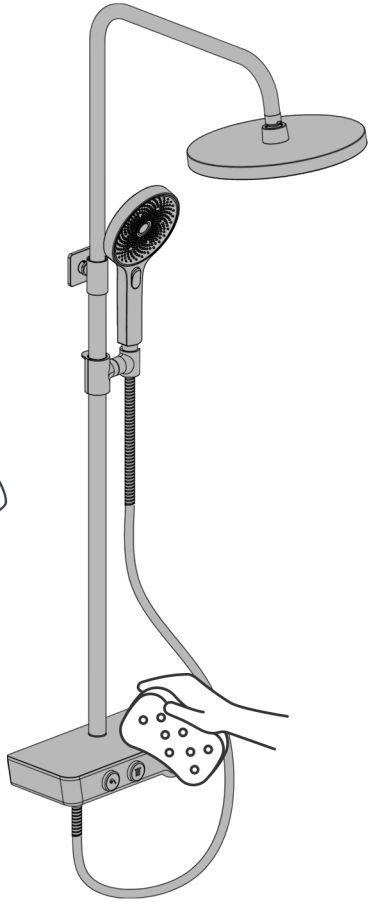

1.



2.

TIPS

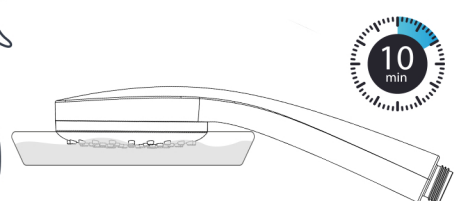
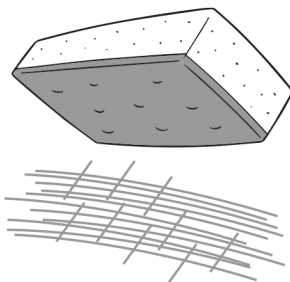
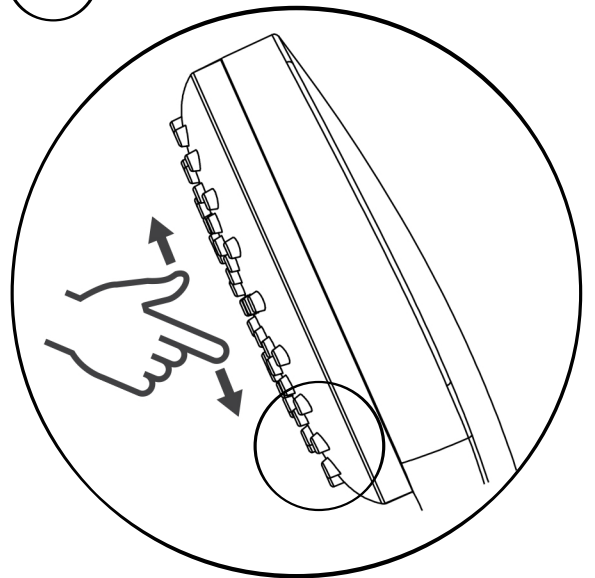

10 min